



MOULDING SELECTION GUIDE

INTERIOR DOORS

Jefferson Door is proud to offer a wide variety of both wood and moulded interior doors. Stop by our showroom to browse our extensive inventory. If you don't see exactly what you are looking for, don't worry! Both special order and custom doors are available, so we are confident that we can get you that hard-to-find door.

EXTERIOR DOORS

No matter what style entry door you're looking for, Jefferson Door can fulfill your vision. We work with many suppliers to offer a diverse range of products. We also carry fiberglass exterior doors for the maintenance-conscious homeowner.

CABINETS

Our kitchen and bath designers will help you make your dreams come true! We offer Omega (Pinnacle, Dynasty and Full Access), HomeCrest, Waypoint and Contractor's Choice cabinetry lines to meet every style and budget. Call for an appointment today!

WINDOWS

Our customers are able to choose from a full range of vinyl, wood, and clad windows from our variety of suppliers. We also carry a line of impact windows which offers greater protection from wind-blown debris during storms.

COLUMNS

We stock permacast columns in a wide variety of sizes, both square and round. Plain or decorative Greek Ionic, Roman Corinthian, and Temple of the Winds styles are available. Caps and bases are available to put the finishing touches on your column. Custom sized and shaped permacast columns and wood columns are also available through our specialty department.

STAIR PARTS

Jefferson Door stocks everything you need to trim out your home's staircase. While we stock Red Oak stair parts, we have access to species such as White Oak, Maple, Brazilian Cherry, and Mahogany as well as wrought iron stair parts.

HARDWARE

We carry both Kwikset and Emtek lines of door hardware. In addition, we stock a wide range of miscellaneous hardware such as closet rods, pocket door frames, and hardware for pocket, bifold, and bypass doors.

CONTENTS

CROWN MOULDING

Page 3

CASING

Page 6

BASEBOARD

Page 9

CHAIR RAIL

Page 11

ASTRAGALS

Page 11

COVE MOULDING

Page 12

MISCELLANEOUS

Page 14

CROWN MOULDING

Crown moulding adds beautiful architectural detail to your home and can be combined with crown enhancer, as well as other mouldings, to increase its size and effect.

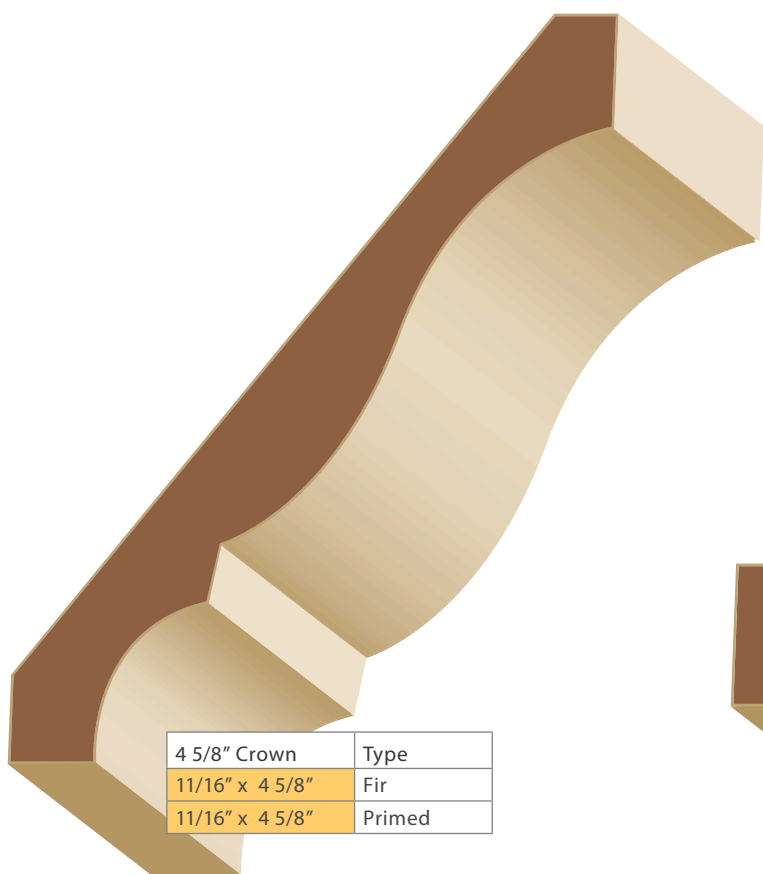

4 5/8" Crown	Type
11/16" x 4 5/8"	Fir
11/16" x 4 5/8"	Primed

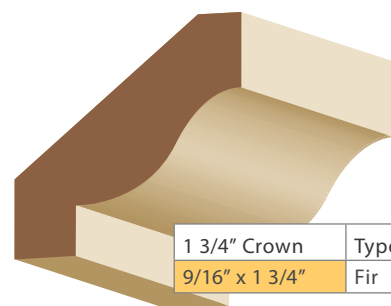

1 3/4" Crown	Type
9/16" x 1 3/4"	Fir

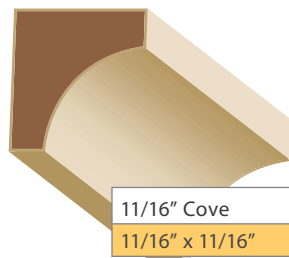

11/16" Cove	Type
11/16" x 11/16"	Fir

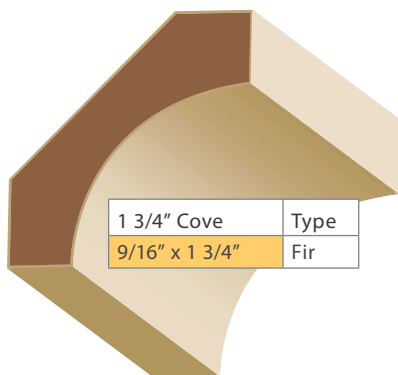

1 3/4" Cove	Type
9/16" x 1 3/4"	Fir

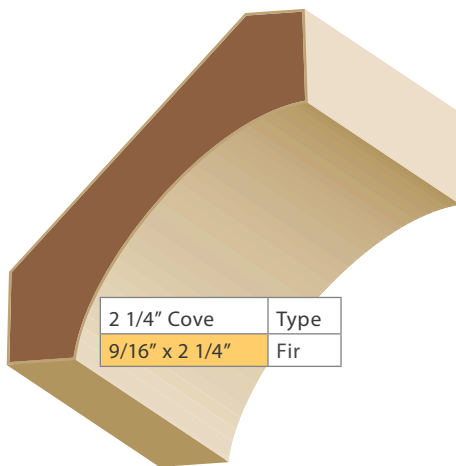

2 1/4" Cove	Type
9/16" x 2 1/4"	Fir

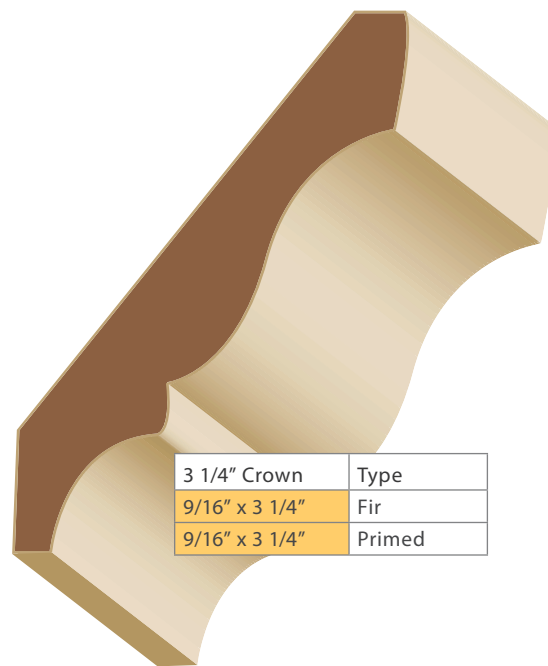

3 1/4" Crown	Type
9/16" x 3 1/4"	Fir
9/16" x 3 1/4"	Primed

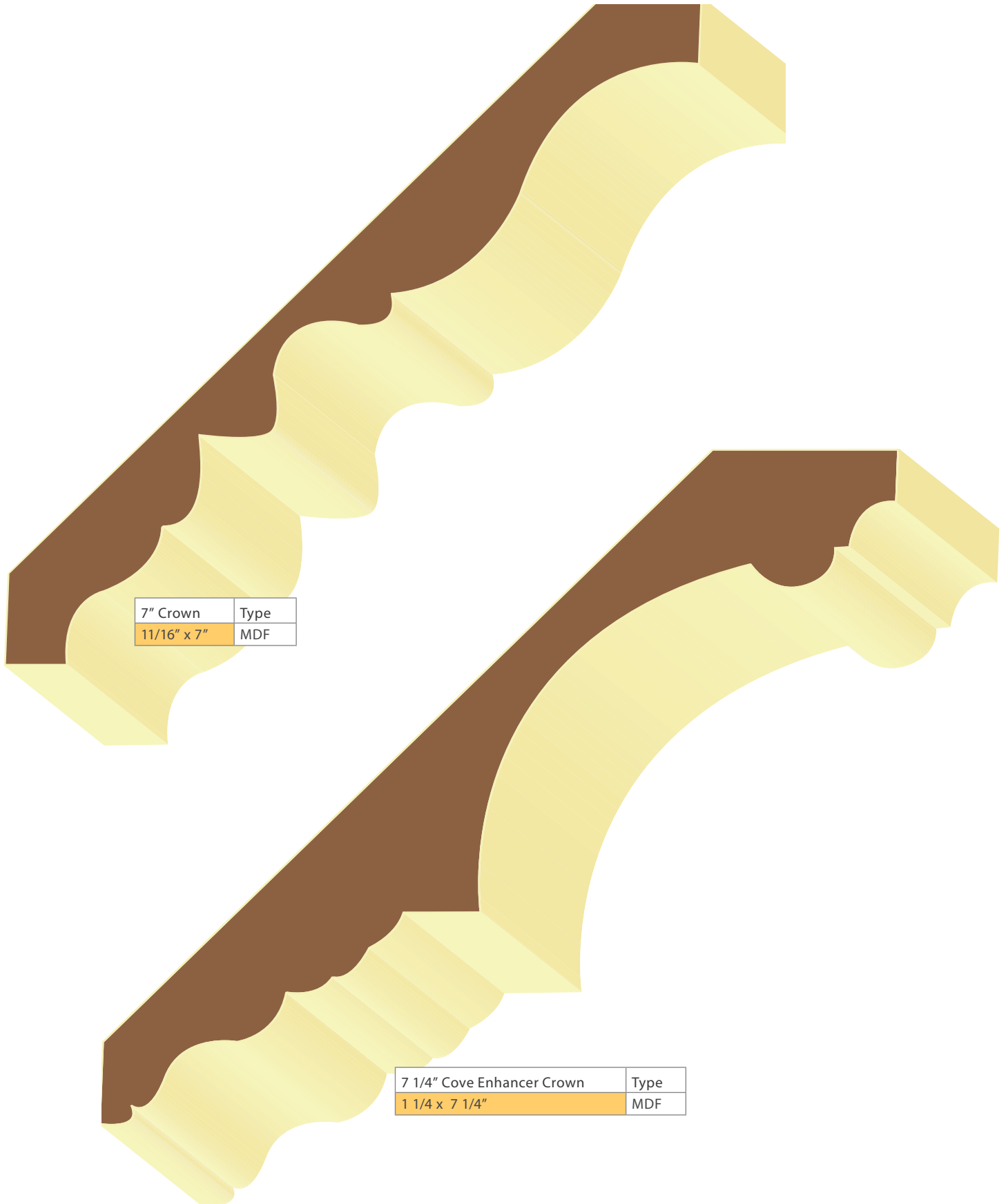

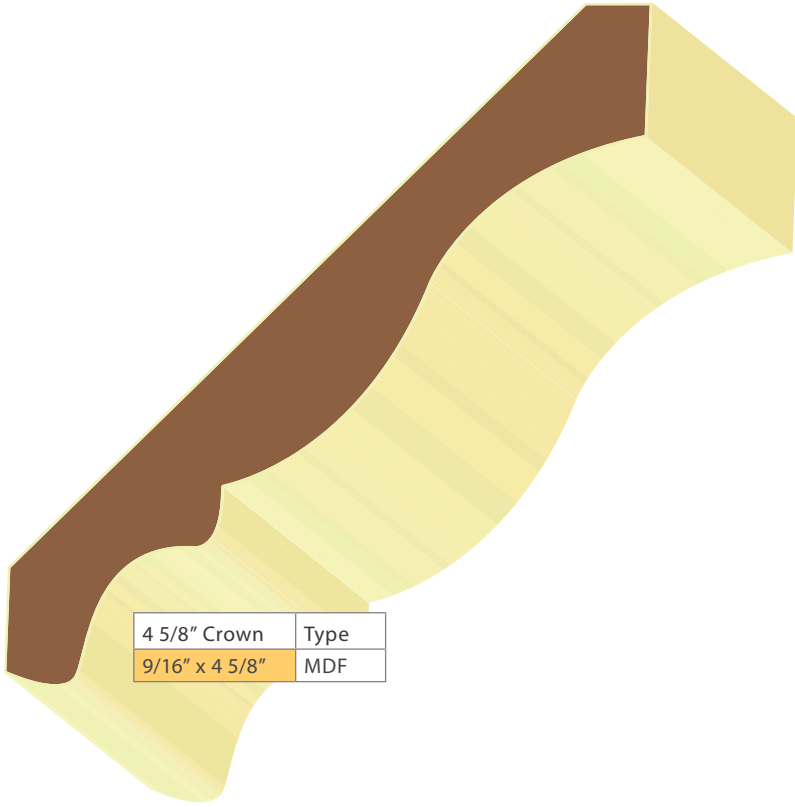

4 5/8" Crown	Type
9/16" x 4 5/8"	MDF

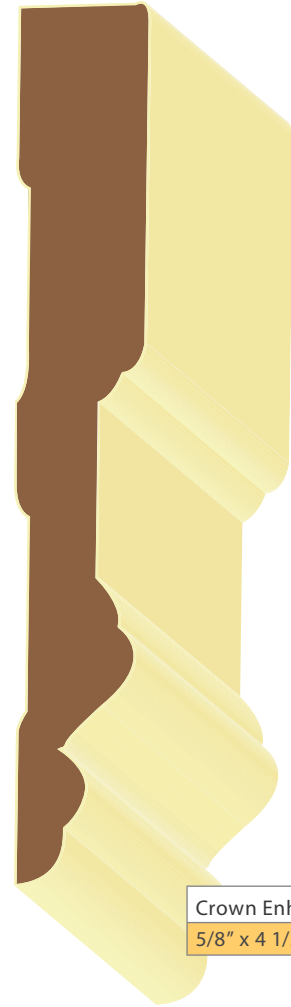

Crown Enhancer	Type
5/8" x 4 1/2"	MDF

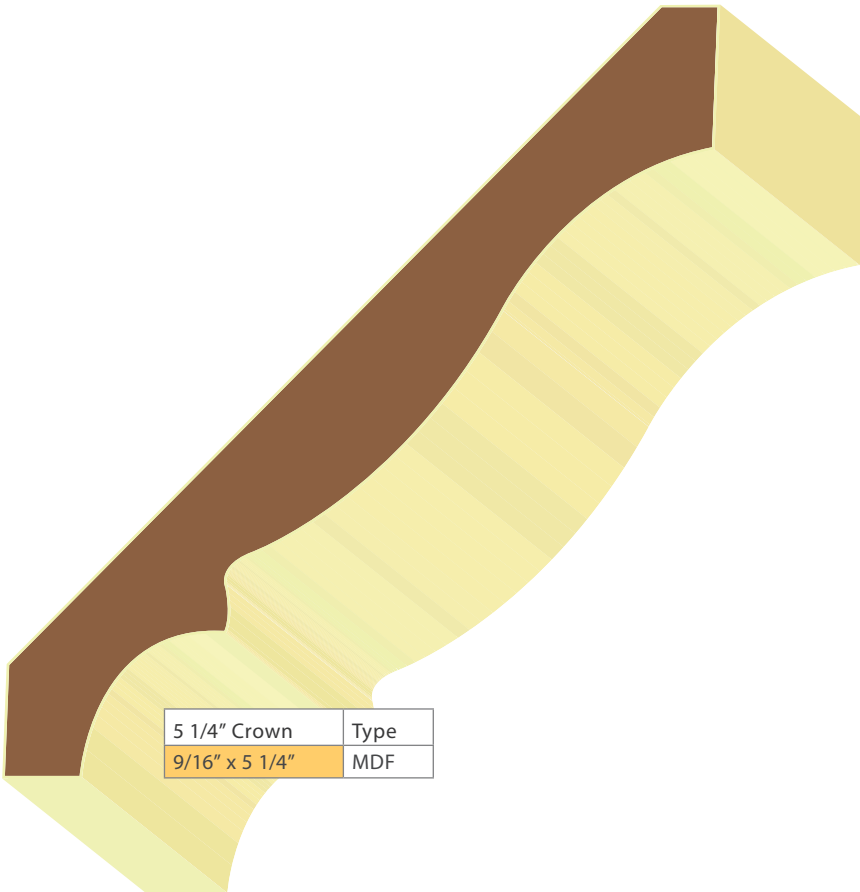

5 1/4" Crown	Type
9/16" x 5 1/4"	MDF

Casing is a finishing trim used around the frames of doors and windows. Casing varies greatly in size and detail. Back band can be combined with regular casing to increase the size and detail of the casing.

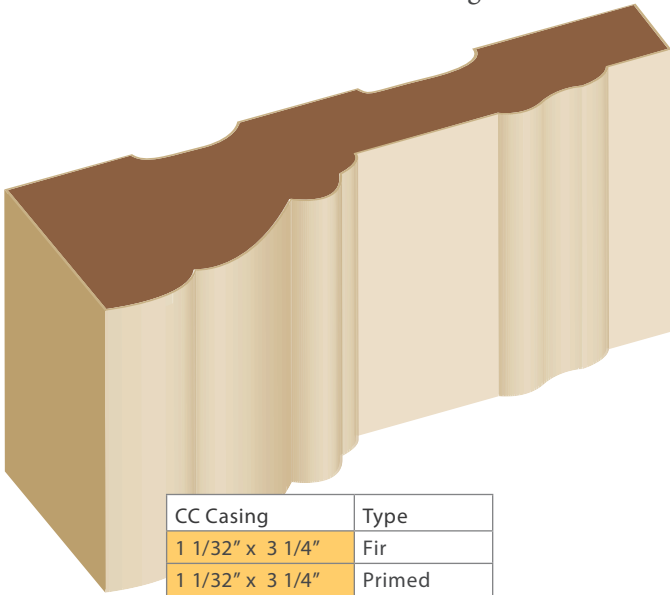

CC Casing	Type
1 1/32" x 3 1/4"	Fir
1 1/32" x 3 1/4"	Primed

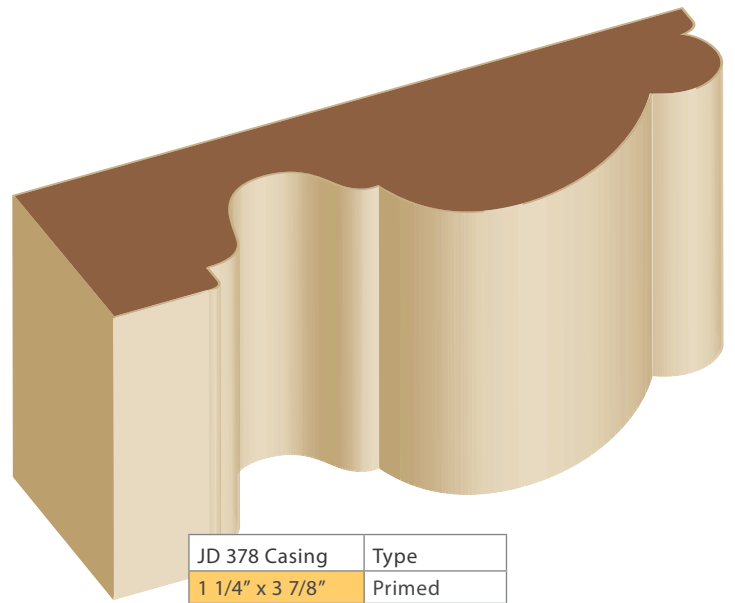

JD 378 Casing	Type
1 1/4" x 3 7/8"	Primed

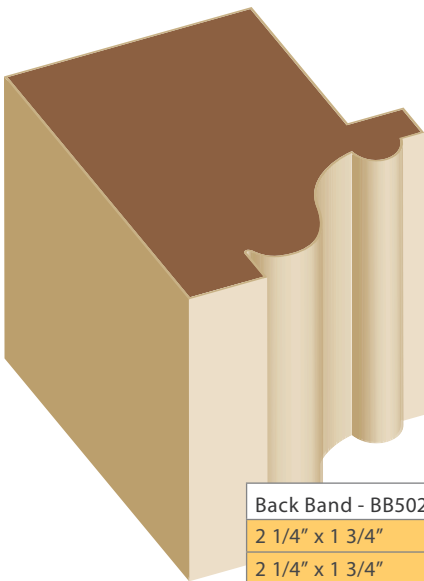

Back Band - BB502	Type
2 1/4" x 1 3/4"	Fir
2 1/4" x 1 3/4"	Primed

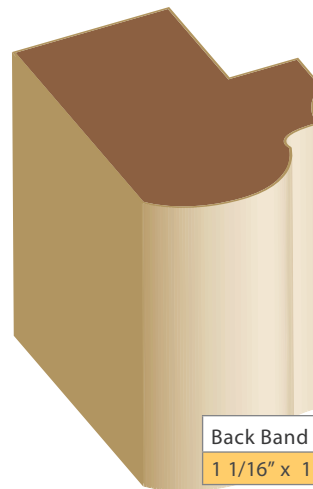

Back Band	Type
1 1/16" x 1 11/16"	Primed

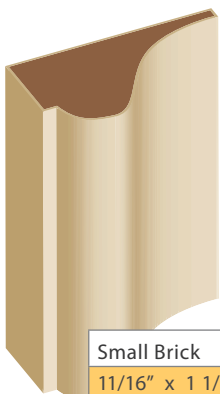

Small Brick	Type
11/16" x 1 1/8"	Fir

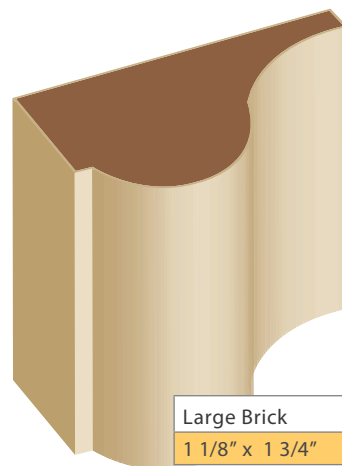

Large Brick	Type
1 1/8" x 1 3/4"	Fir

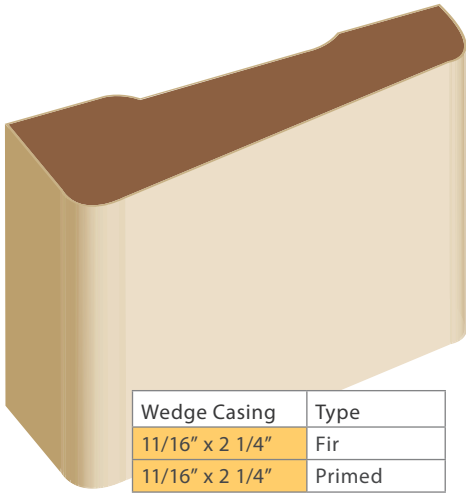

Wedge Casing	Type
11/16" x 2 1/4"	Fir
11/16" x 2 1/4"	Primed

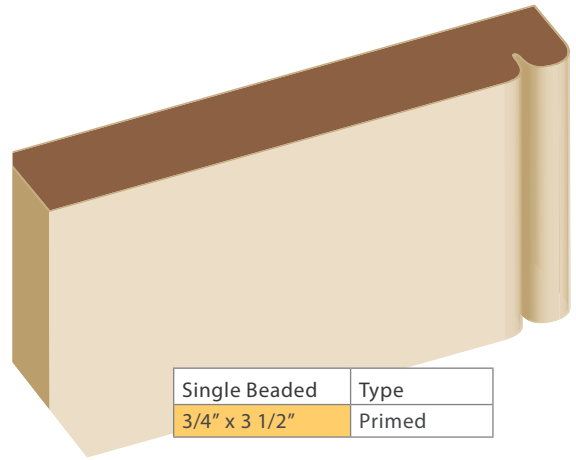

Single Beaded	Type
3/4" x 3 1/2"	Primed

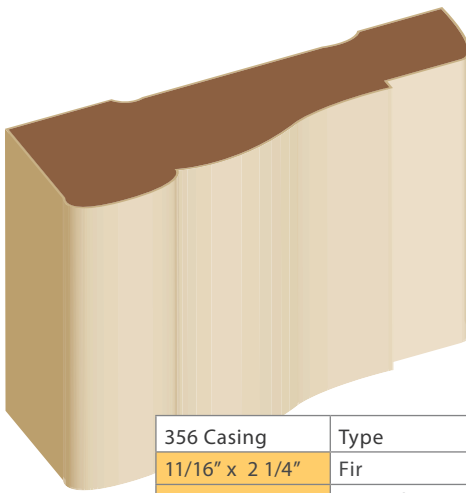

356 Casing	Type
11/16" x 2 1/4"	Fir
11/16" x 2 1/4"	Primed

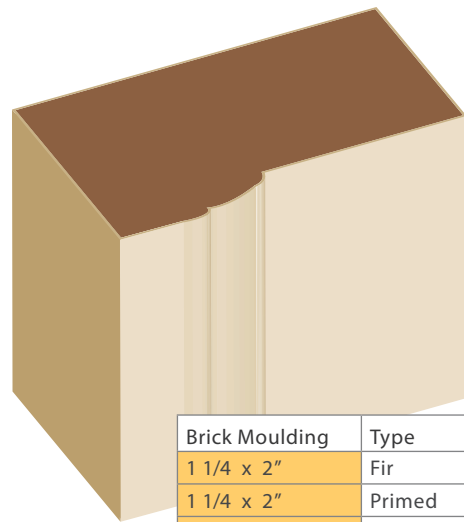

Brick Moulding	Type
1 1/4 x 2"	Fir
1 1/4 x 2"	Primed
1 1/4 x 2"	Polyurethane

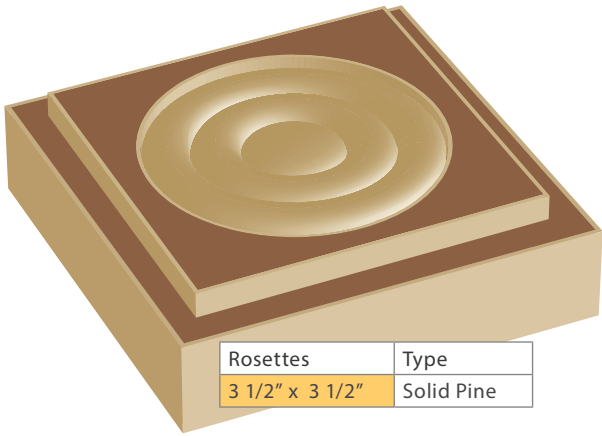

Rosettes	Type
3 1/2" x 3 1/2"	Solid Pine

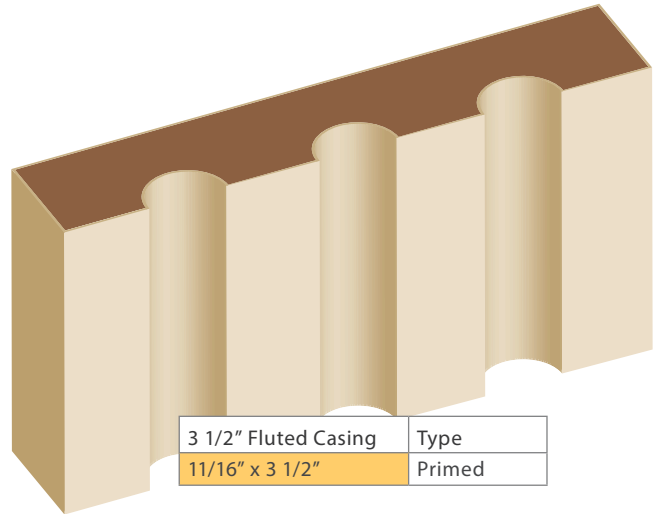

3 1/2" Fluted Casing	Type
11/16" x 3 1/2"	Primed

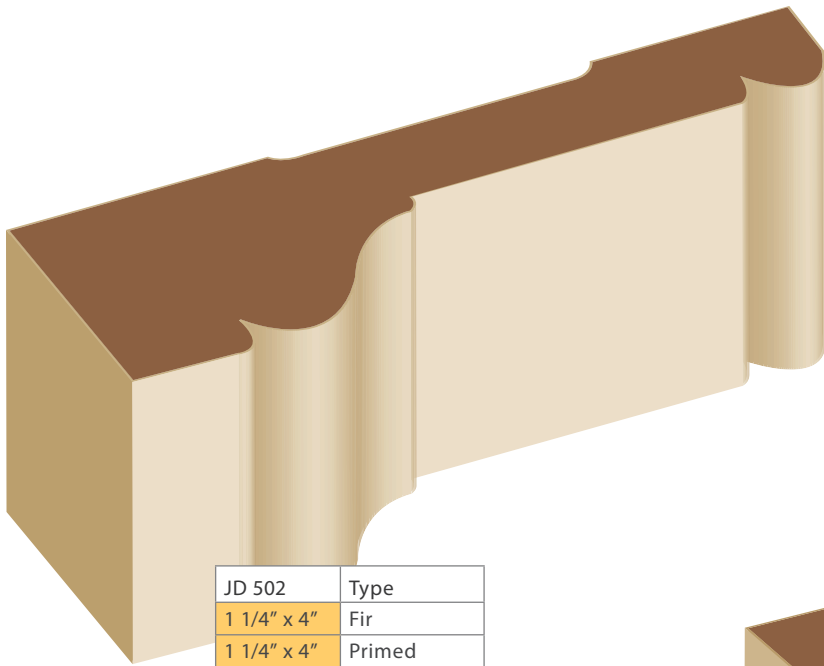

JD 502	Type
1 1/4" x 4"	Fir
1 1/4" x 4"	Primed

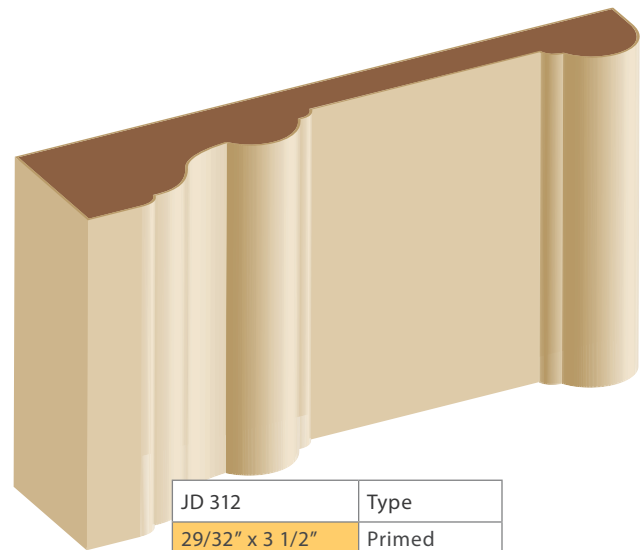

JD 312	Type
29/32" x 3 1/2"	Primed

Baseboard is used along the bottom of a wall where the wall meets the floor, to both protect the wall from impact as well as to add architectural detail to the home. Baseboard comes in a variety of stock sizes, but custom sizes can easily be made with the use of base cap.

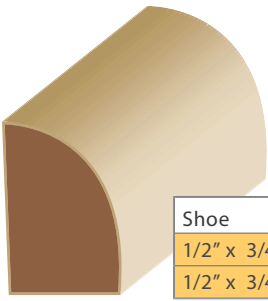

Shoe	Type
1/2" x 3/4"	Fir
1/2" x 3/4"	Primed

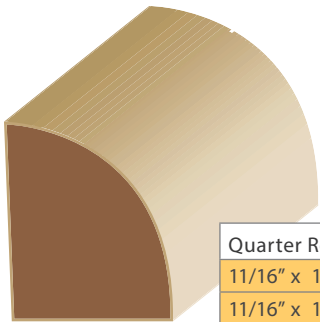

Quarter Round	Type
11/16" x 11/16"	Fir
11/16" x 11/16"	Primed

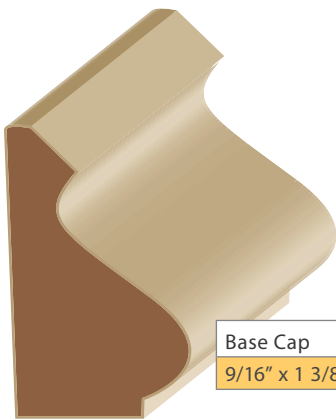

Base Cap	Type
9/16" x 1 3/8"	Primed

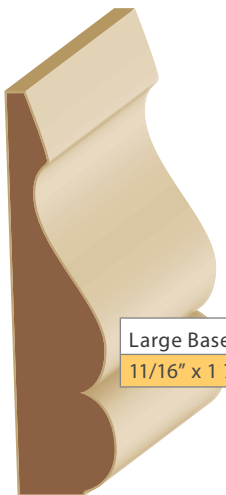

Large Base Cap	Type
11/16" x 1 7/8"	Primed

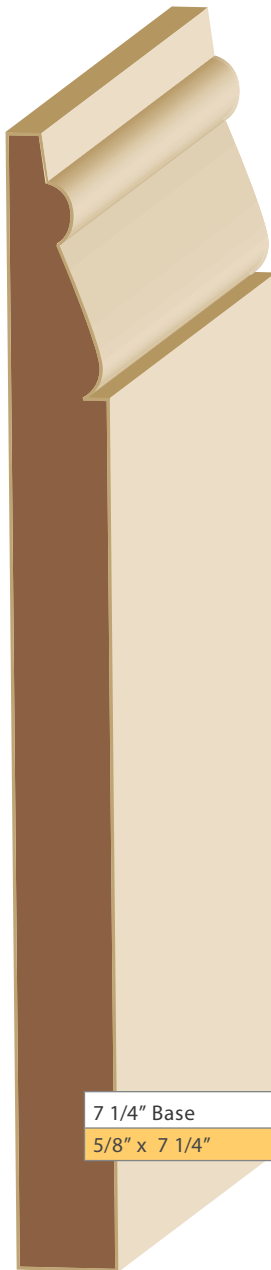

7 1/4" Base	Type
5/8" x 7 1/4"	Primed

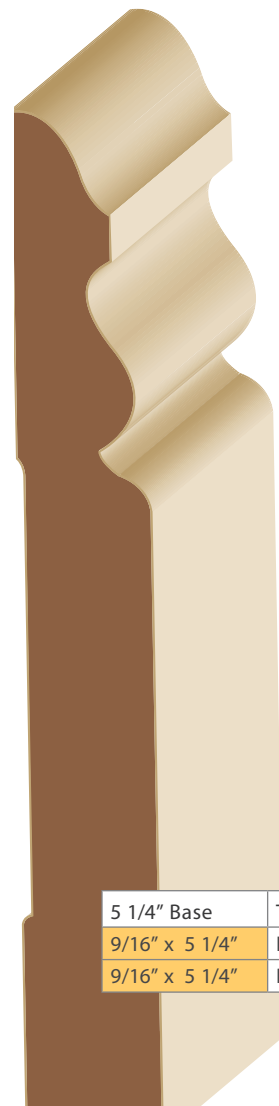

5 1/4" Base	Type
9/16" x 5 1/4"	Fir
9/16" x 5 1/4"	Primed

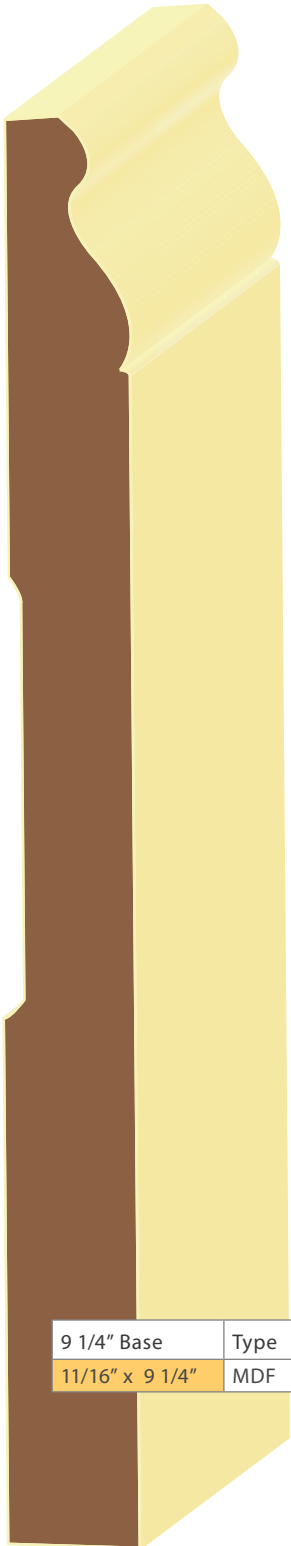

9 1/4" Base	Type
11/16" x 9 1/4"	MDF

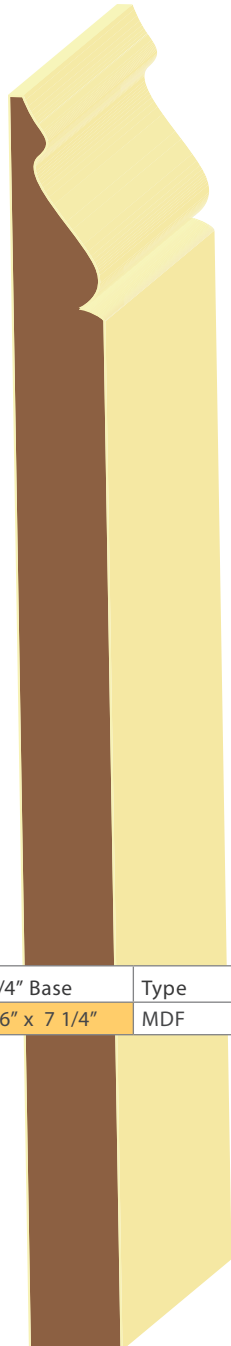

7 1/4" Base	Type
9/16" x 7 1/4"	MDF

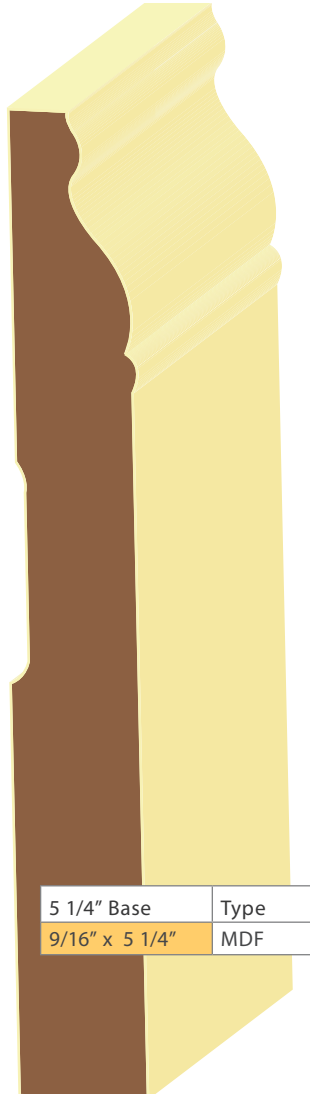

5 1/4" Base	Type
9/16" x 5 1/4"	MDF

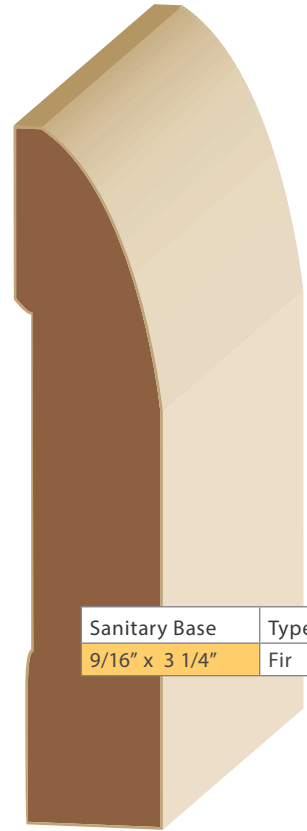

Sanitary Base	Type
9/16" x 3 1/4"	Fir

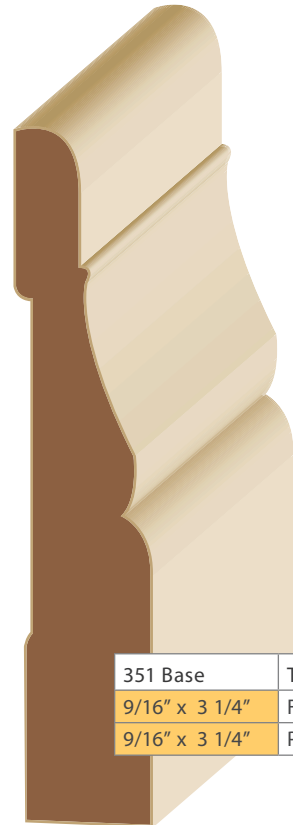

351 Base	Type
9/16" x 3 1/4"	Fir
9/16" x 3 1/4"	Primed

Chair rail is moulding placed part way up a wall to protect the wall from chair-backs. It is also commonly used simply for decorative purposes.

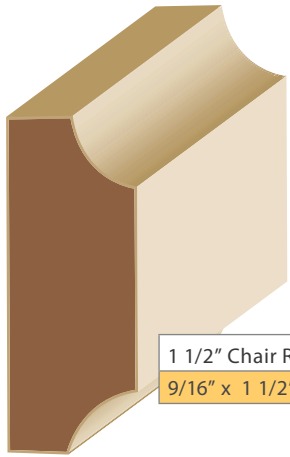

1 1/2" Chair Rail	Type
9/16" x 1 1/2"	Primed

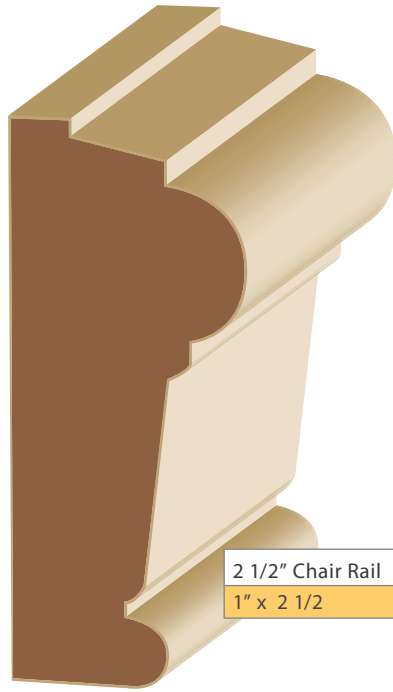

2 1/2" Chair Rail	Type
1" x 2 1/2"	Primed

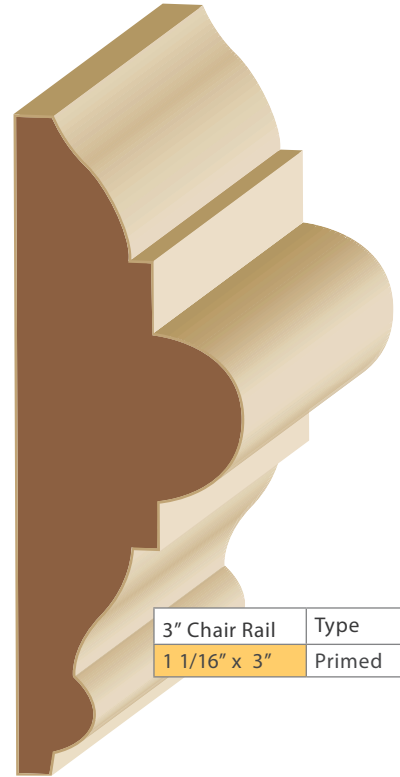

3" Chair Rail	Type
1 1/16" x 3"	Primed

ASTRAGALS

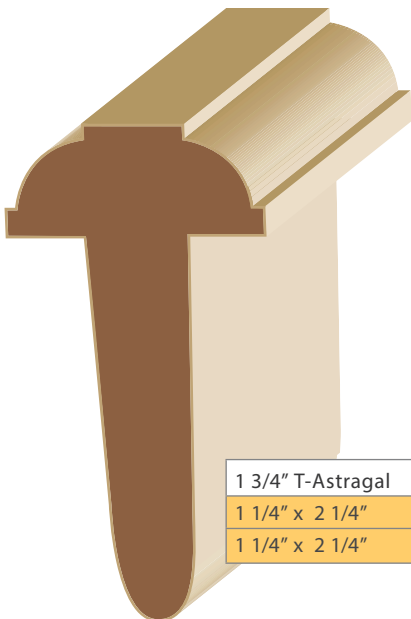

1 3/4" T-Astragal	Type
1 1/4" x 2 1/4"	Fir
1 1/4" x 2 1/4"	Primed

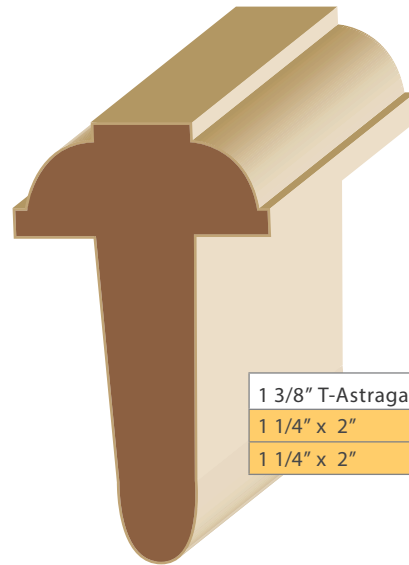

1 3/8" T-Astragal	Type
1 1/4" x 2"	Fir
1 1/4" x 2"	Primed

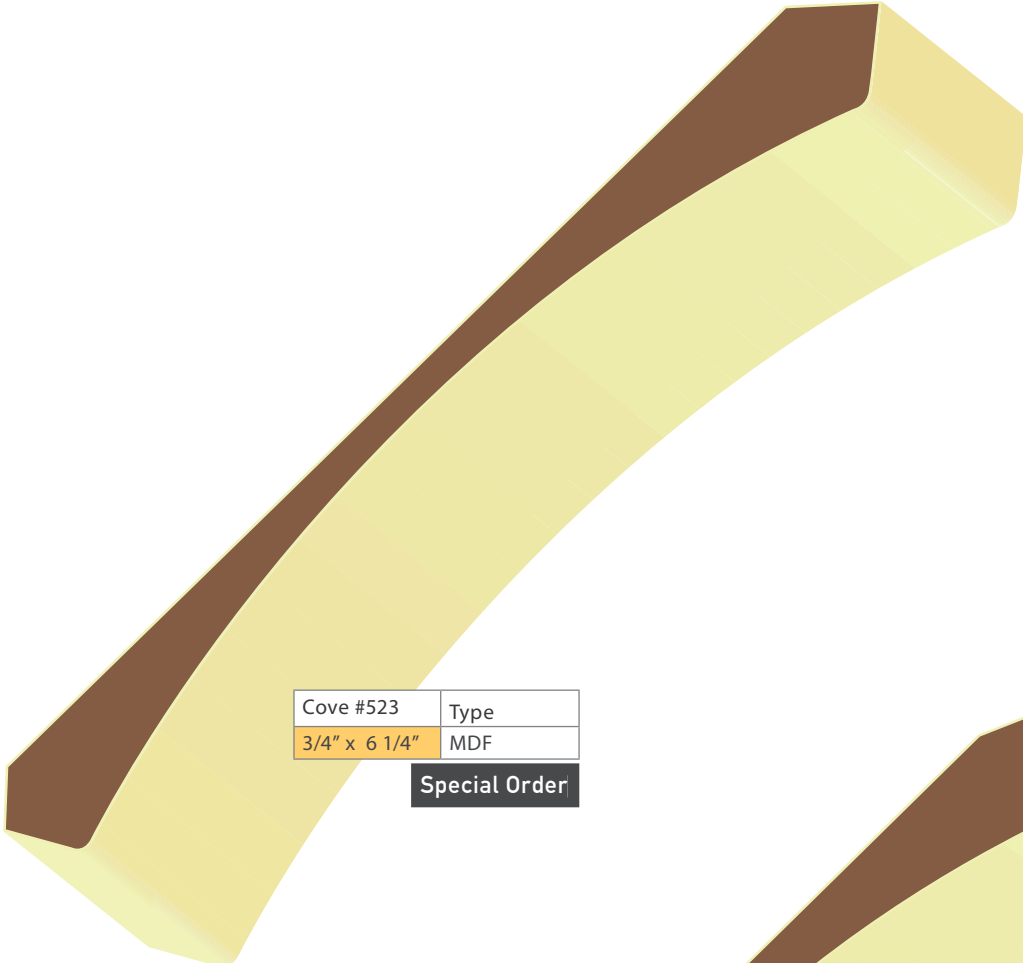

Cove #523	Type
3/4" x 6 1/4"	MDF

Special Order



Cove #505	Type
1' x 7'	MDF

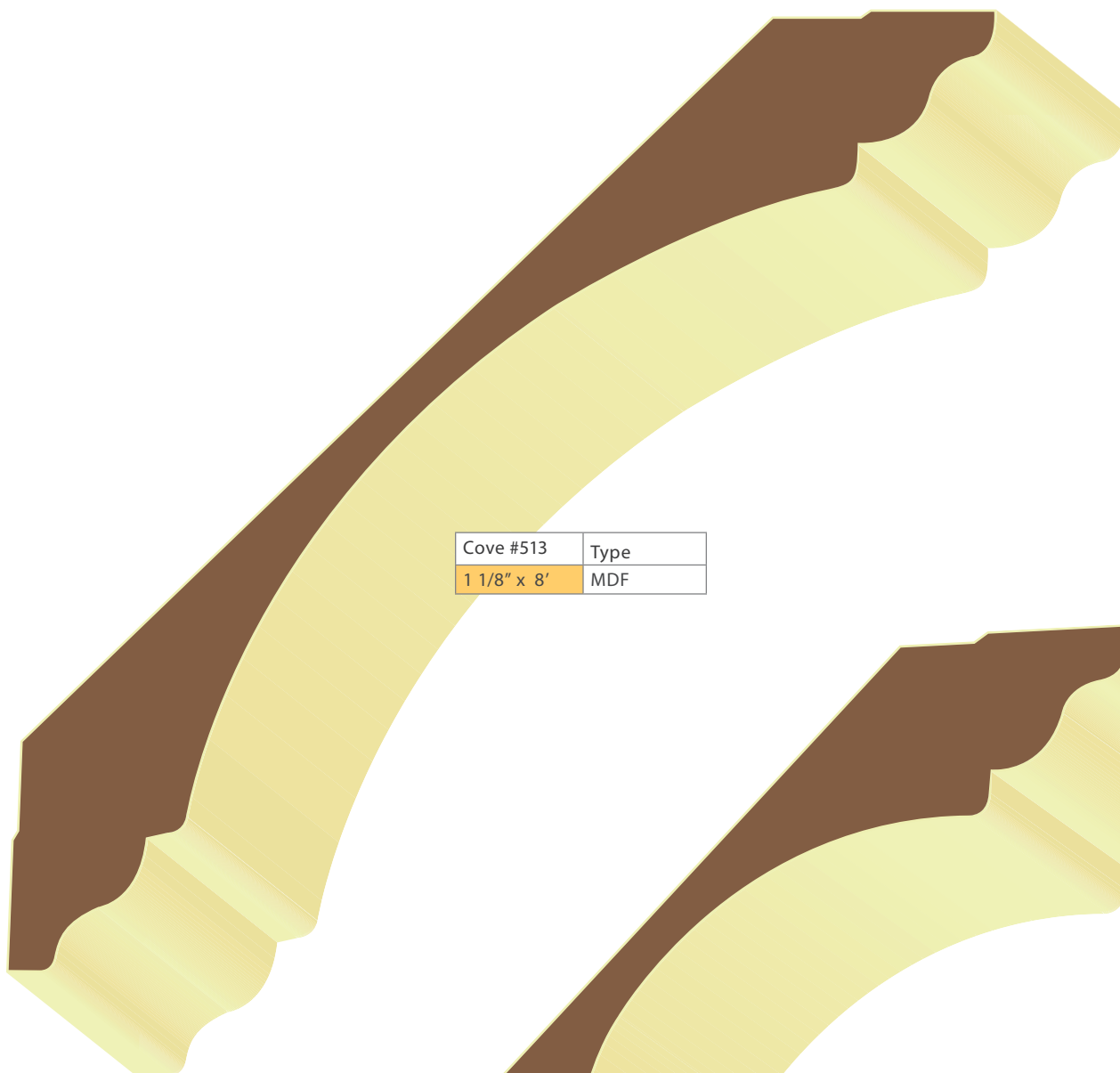

Cove #513	Type
1 1/8" x 8'	MDF



Cove #500	Type
1 1/8" x 6 5/16"	MDF

MISCELLANEOUS

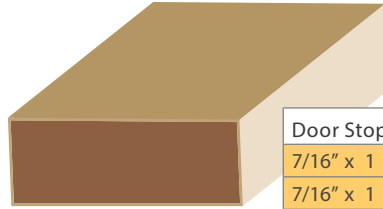

Door Stop	Type
7/16" x 1 1/8"	Fir
7/16" x 1 1/8"	Primed

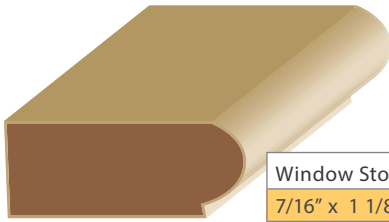

Window Stop	Type
7/16" x 1 1/8"	Pine

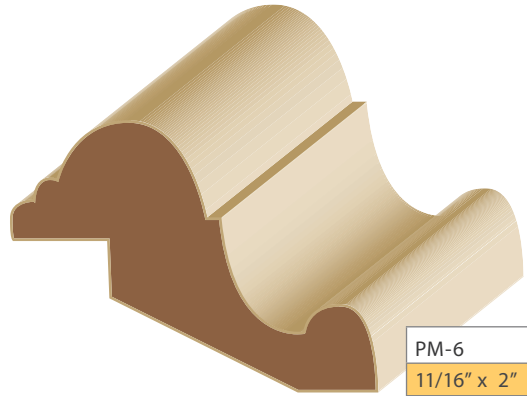

PM-6	Type
11/16" x 2"	Primed

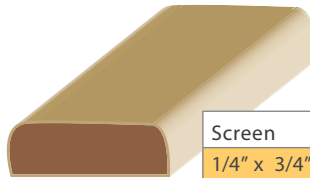

Screen	Type
1/4" x 3/4"	Pine

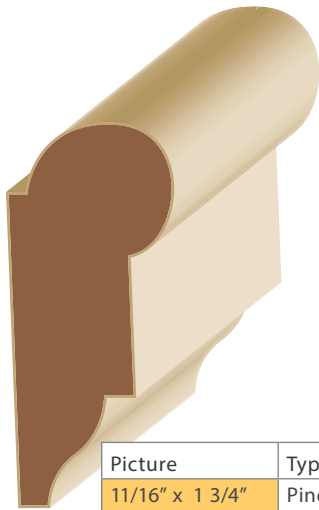

Picture	Type
11/16" x 1 3/4"	Pine

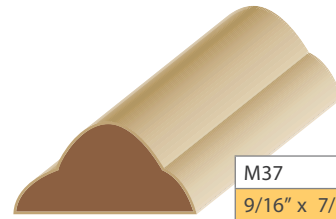

M37	Type
9/16" x 7/16"	Primed



Glass Bead	Type
3/8" x 7/16"	Fir

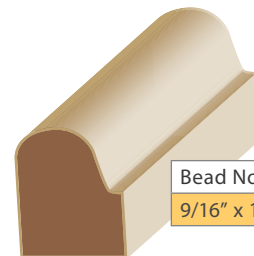

Bead Nosing	Type
9/16" x 11/16"	Primed

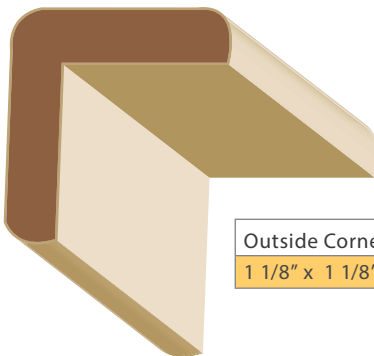

Outside Corner	Type
1 1/8" x 1 1/8"	Pine

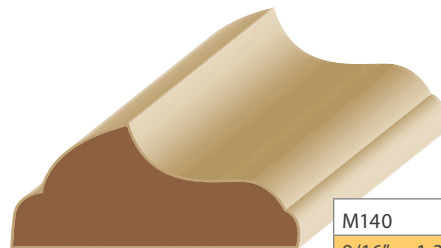

M140	Type
9/16" x 1 3/8"	Primed

WE MAKE RENOVATING EASY

Building a new home or renovating, while rewarding, can also be stressful. Our sales team knows this and will make the process of choosing the millwork for your home an easy and enjoyable experience. Our showroom allows you to see and “put your hands on” our large selection of moulding, windows, doors, columns, cabinets, stair parts, and hardware. Our variety of suppliers allows us to meet any budget, large or small.

Stop by our showroom to speak with a sales consultant today!

VISIT OUR SHOWROOM

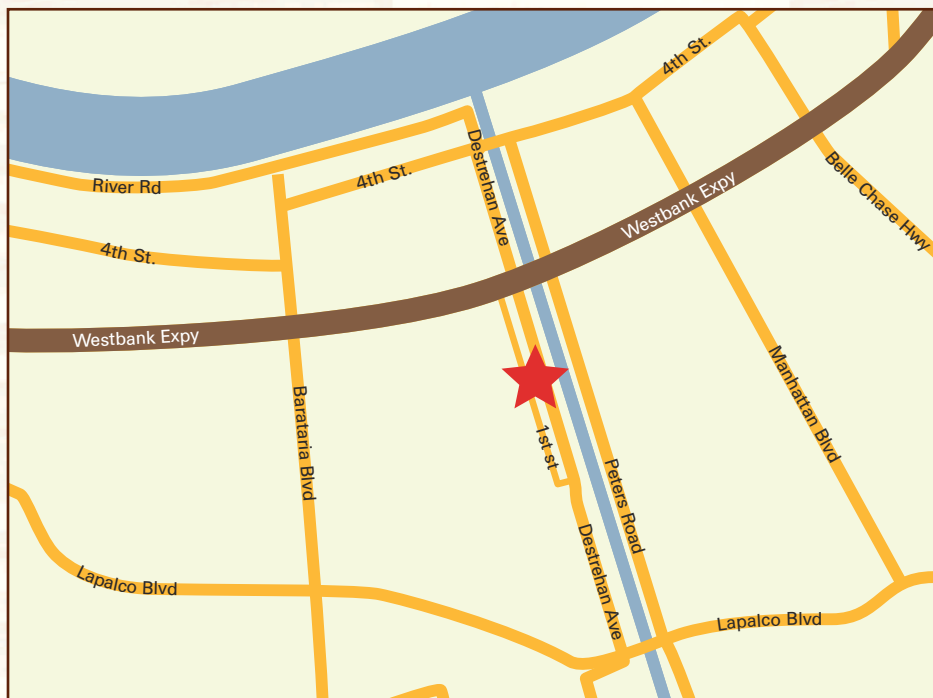

Showroom hours are 7:00am - 5:00pm Monday - Friday.
Warehouse Closes to pick-ups at 4:00pm.

SHOWROOM

1227 First Ave.
Harvey, LA 70058

CONTACT US

Phone: 504.340.2471
Fax: 504.348.4187

ONLINE

jeffersondoor.com
info@Jeffersondoor.com

At Jefferson Door, we are proud to offer you the finest products available from only the top manufacturers of high quality doors, cabinets, windows and more.

DOORS

Rogue Valley Door
Glass Craft
ODL
RSL Inc.
Masonite
A.A.W., Inc.

WINDOWS

Marvin
Weather Shield
Sierra Pacific
Boral Windows
Showcase
Hy-Lite

COLUMNS

HB&G

MOULDING

Carter Millwork
Fypon

HARDWARE

BHP
Kwikset
Emtek
Hager
Johnson

CABINETS

Omega - Pinnacle,
Dynasty & Full Access
HomeCrest
Waypoint
Contractor's Choice

STAIR PARTS

Louisville Ladder
Southwest Moulding Co.
L.J. Smith
Crown Heritage

Check out our entire selection online at
jeffersondoor.com





1227 First Ave. Harvey, LA 70058



Check out our entire selection online at
jeffersondoor.com

